

1. Table of Contents (This Page)
Created on Wed Mar 9 15:02:02 2011

2. component

3. solder

4. outline

5. plated-drill

6. componentmask

7. soldermask

8. topsilk

9. bottomsilk

10. topassembly

11. bottomassembly

12. fab

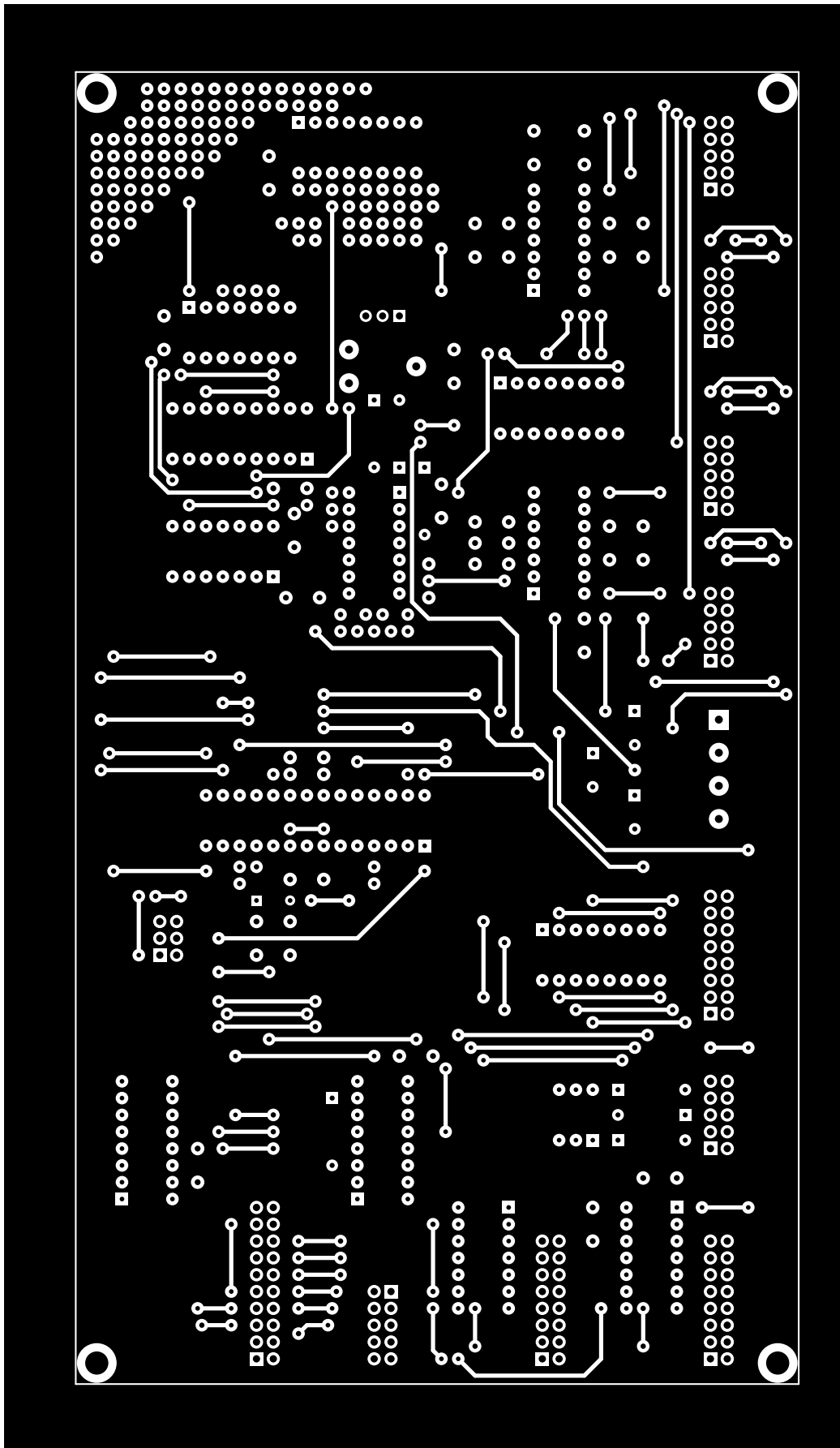

front (mirrored), scale = 1:1.080
pcb/main.pcb

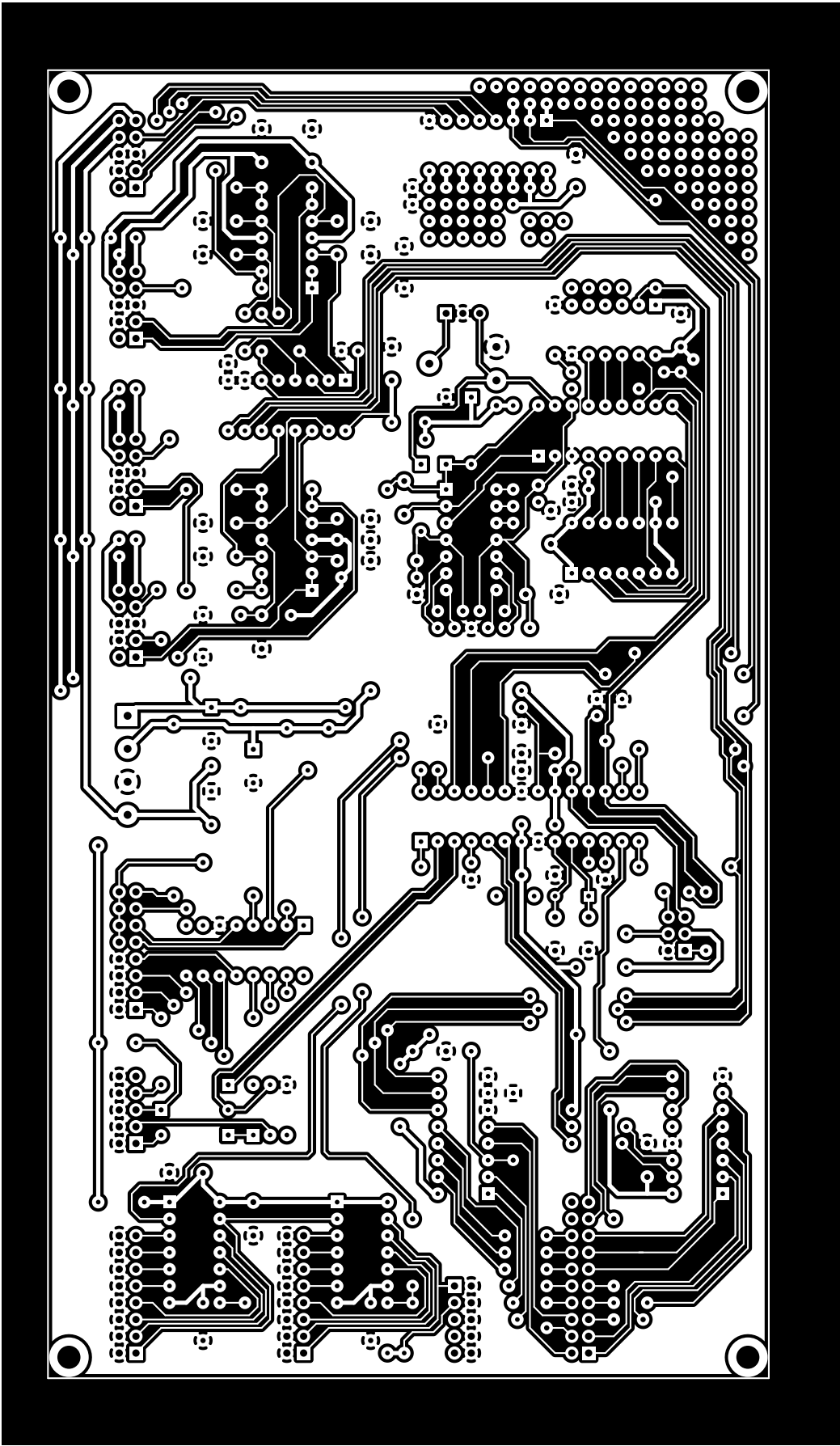

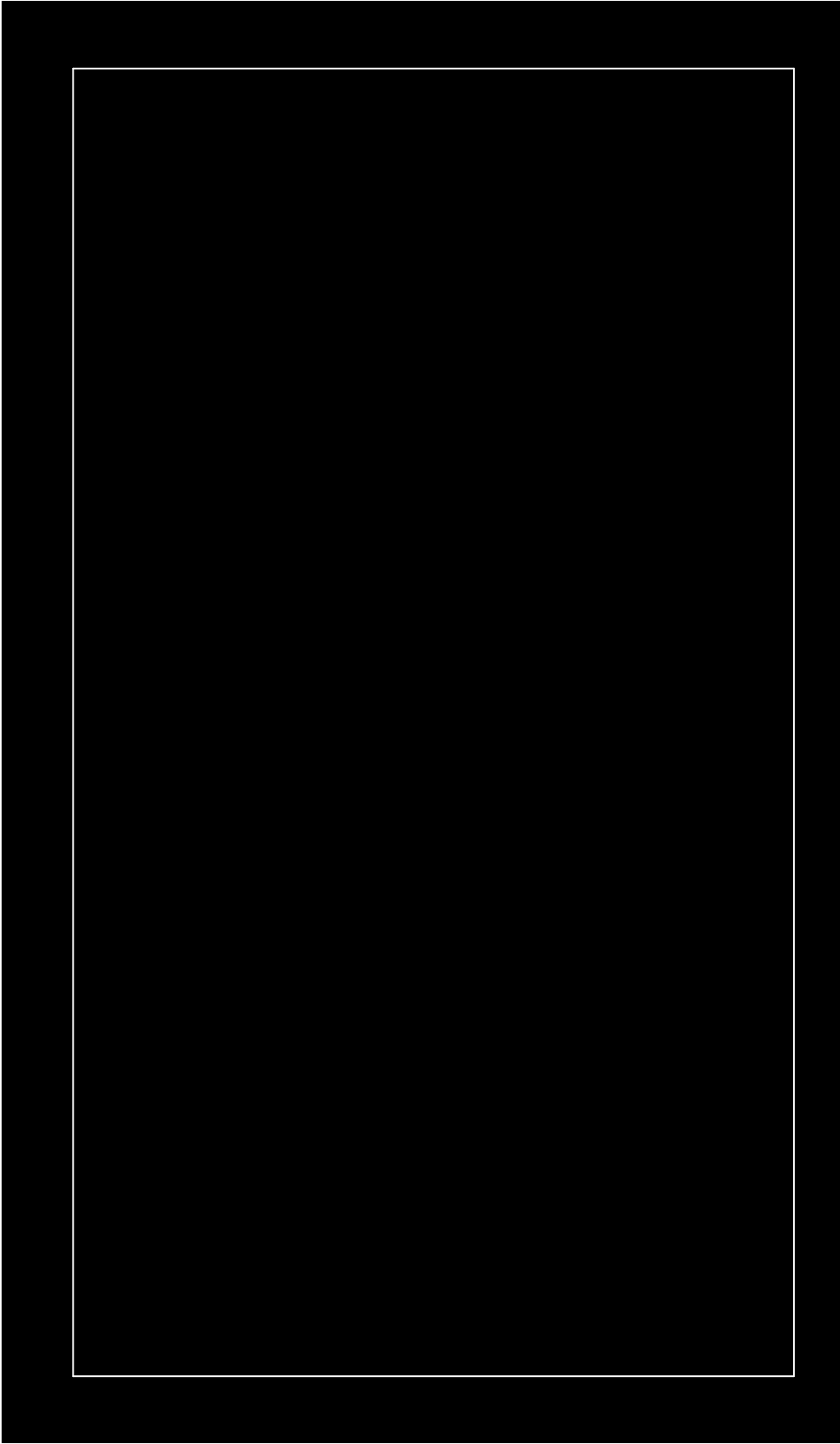

outline (mirrored), scale = 1:1.080
pcb/main.pcb

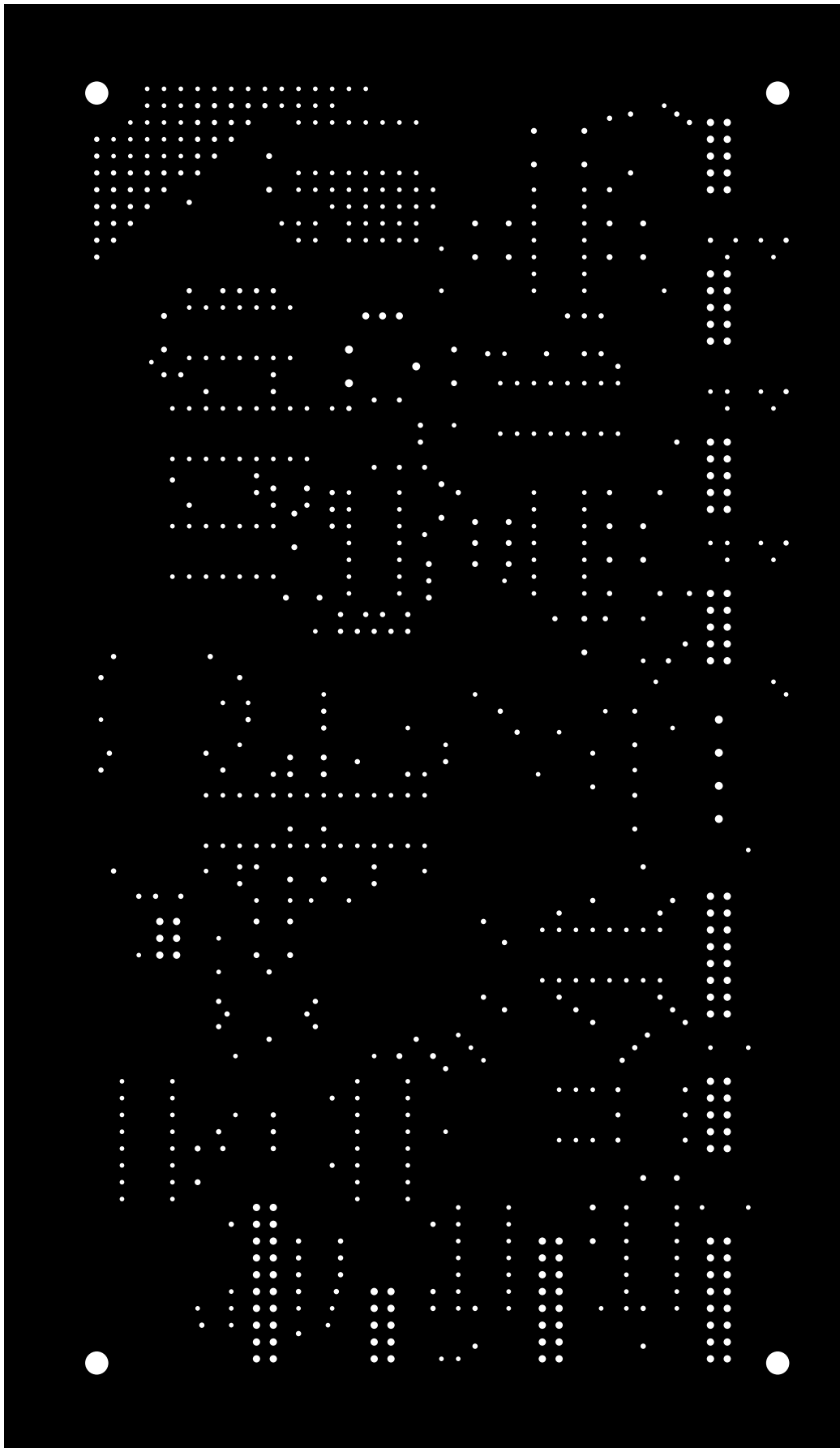

plated-drill (mirrored), scale = 1:1.080
pcb/main.pcb

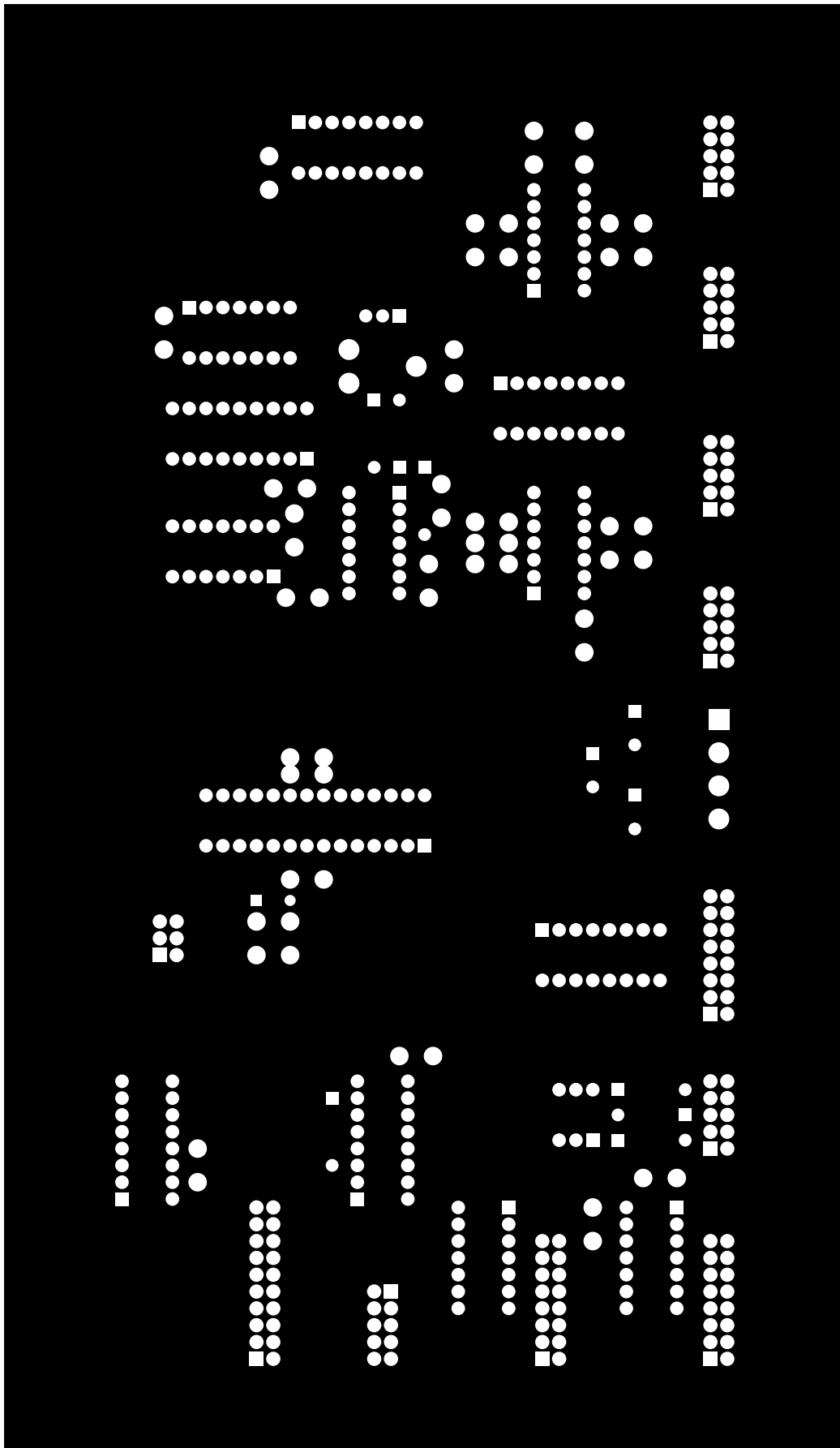

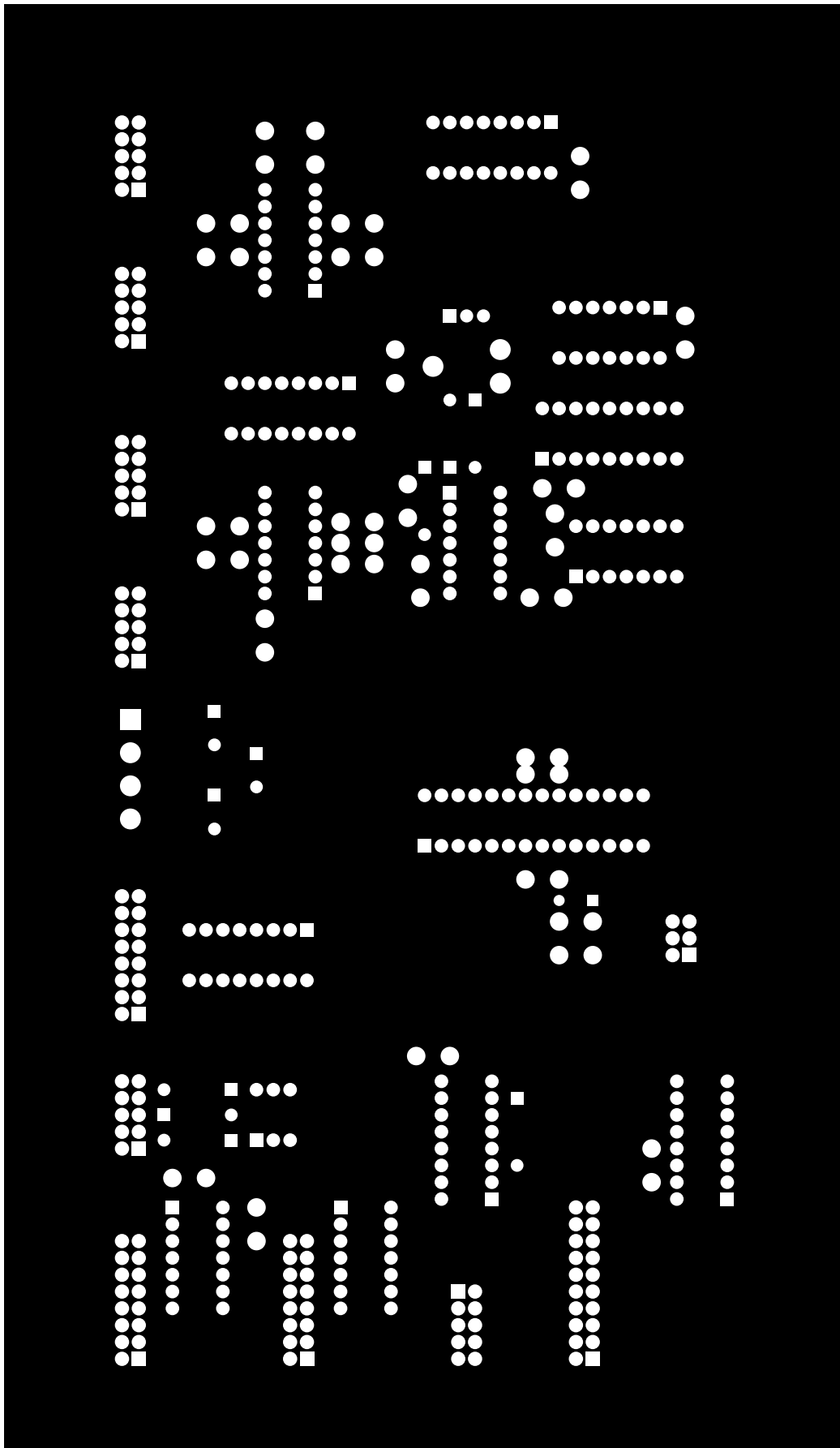

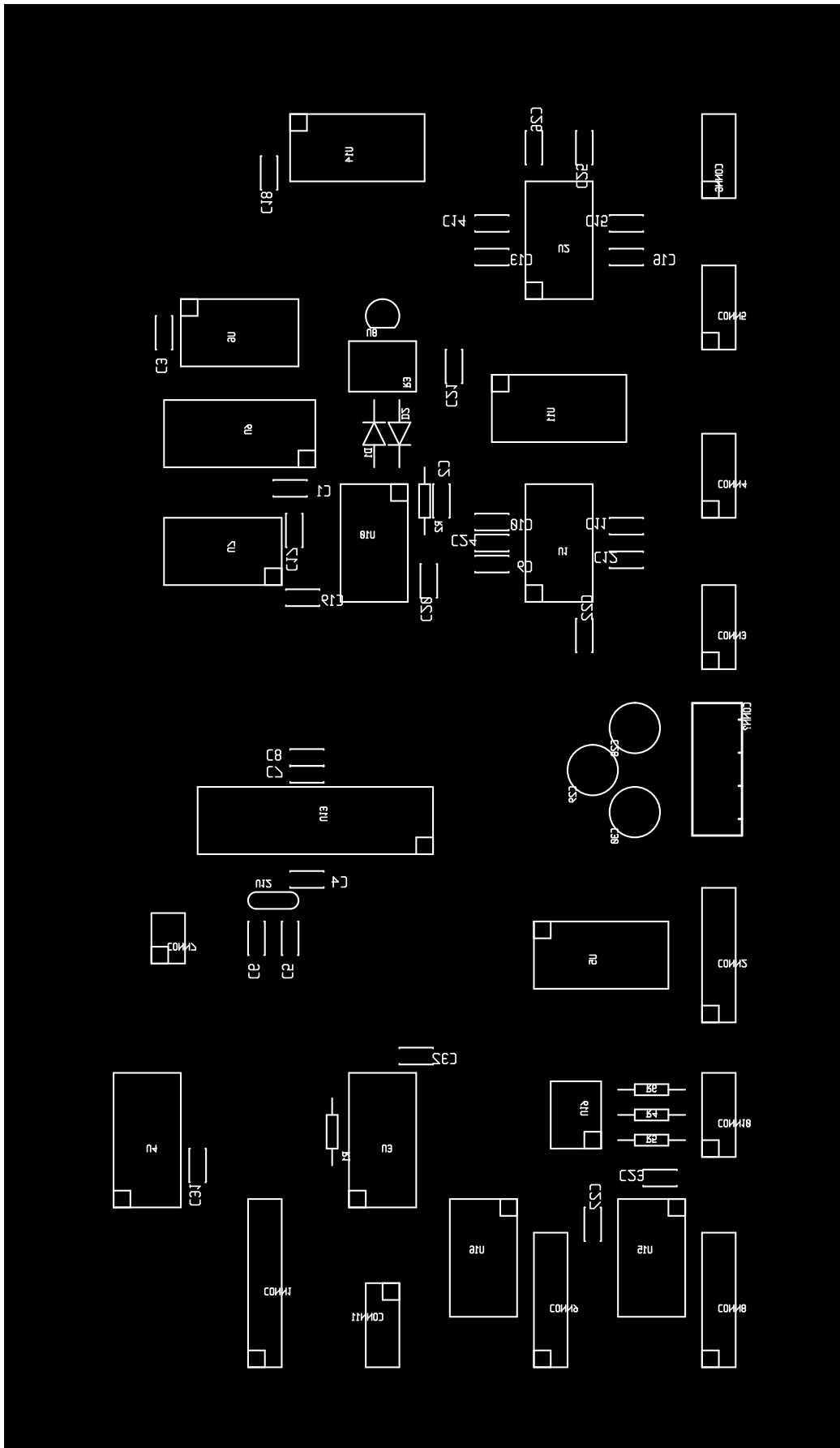

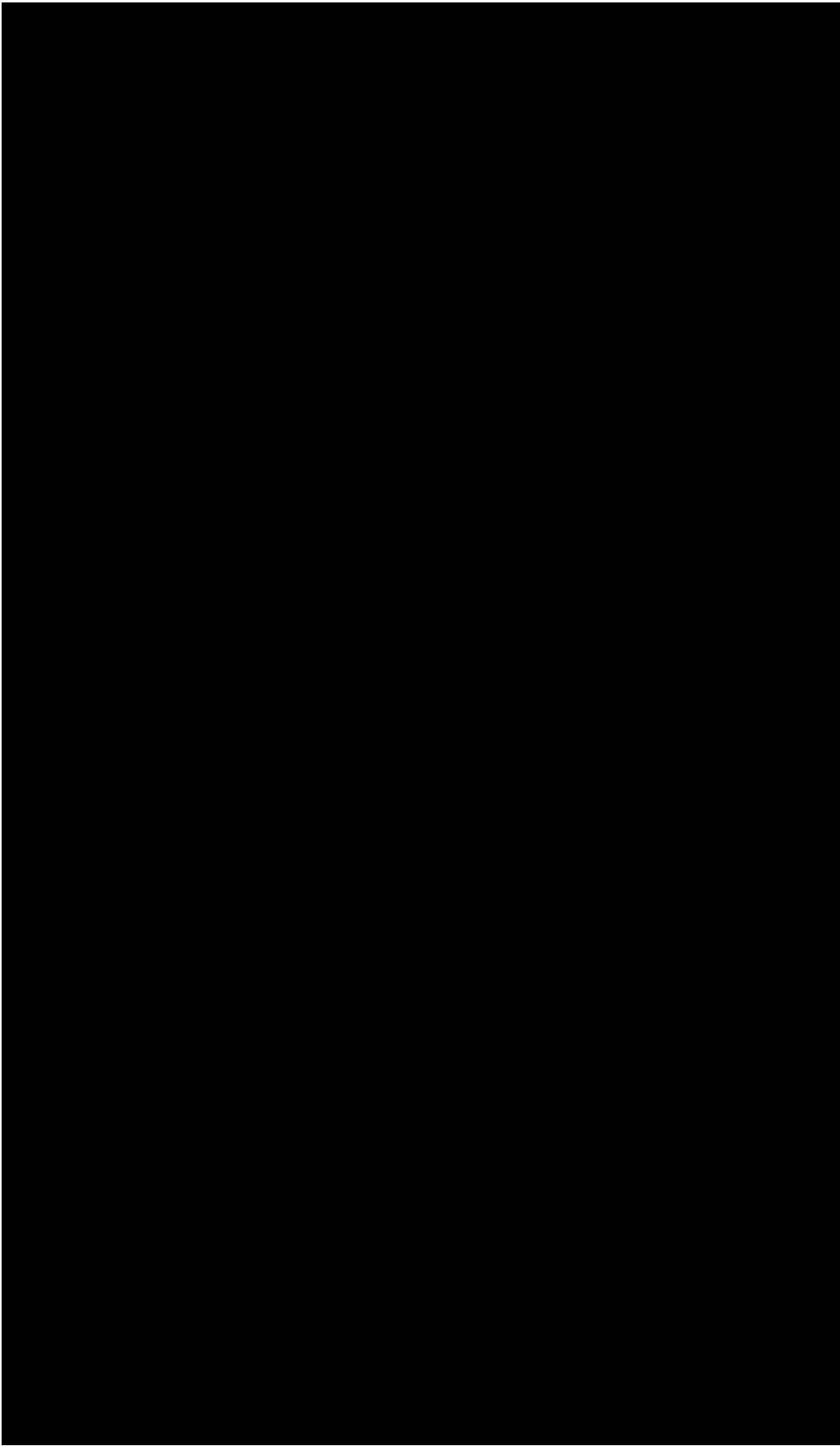

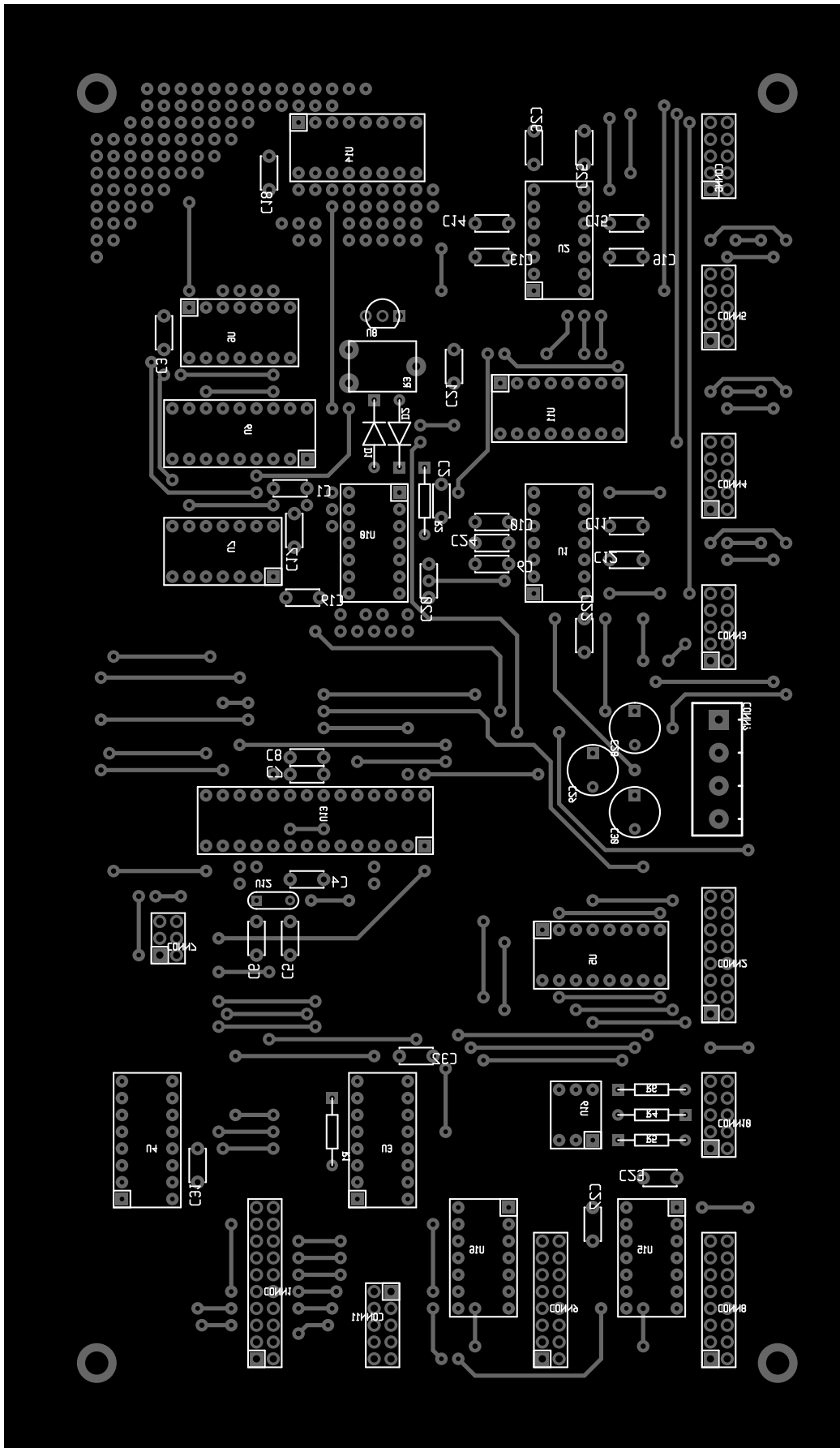

frontassembly (mirrored), scale = 1:1.080
pcb/main.pcb

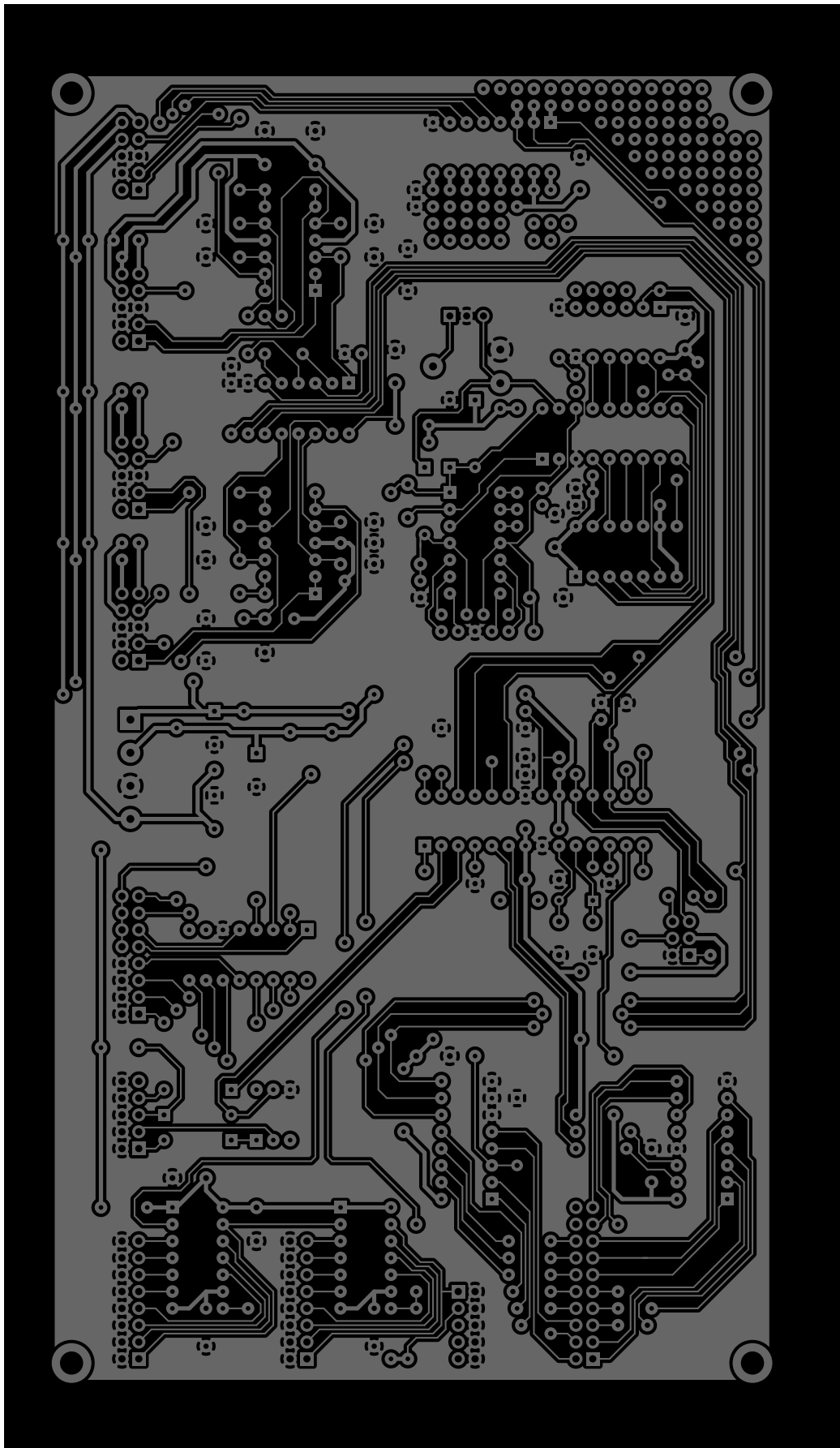

backassembly, scale = 1:1.080
pcb/main.pcb

