

1. Table of Contents (This Page)
Created on Wed Mar 9 15:01:58 2011

2. component

3. solder

4. outline

5. plated-drill

6. componentmask

7. soldermask

8. topsilk

9. bottomsilk

10. topassembly

11. bottomassembly

12. fab

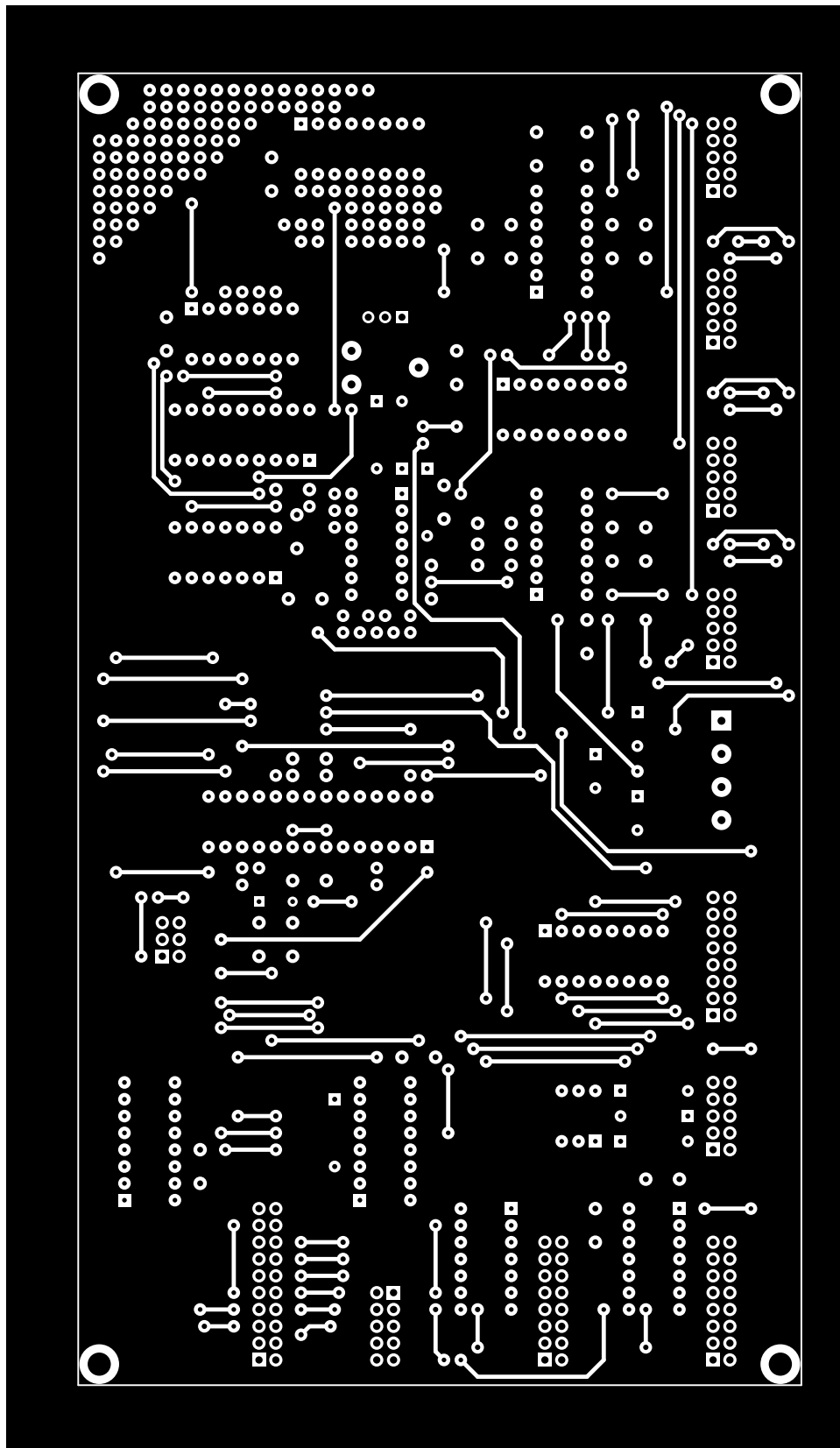

front (mirrored), scale = 1:1.000
pcb/main.pcb

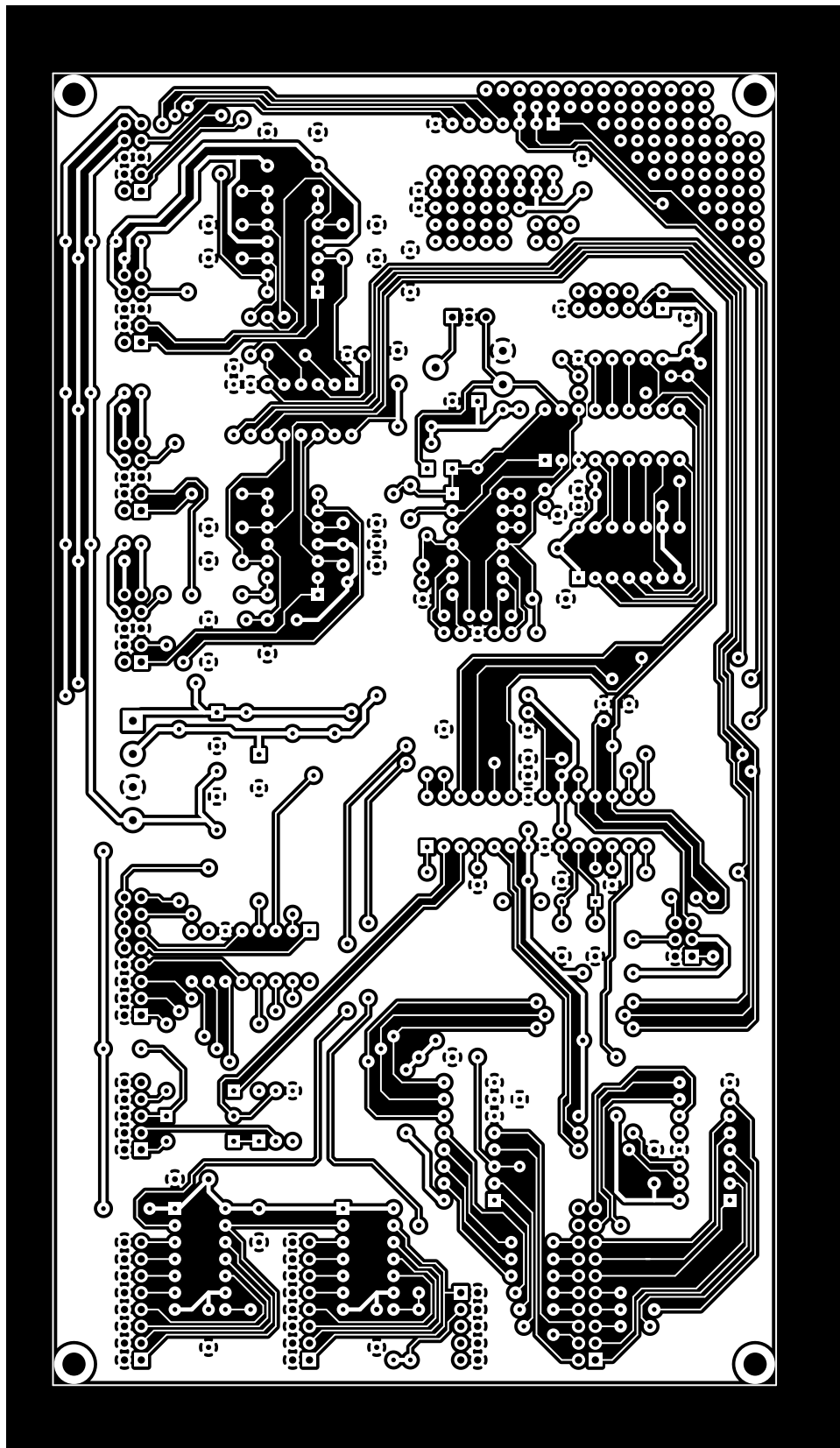

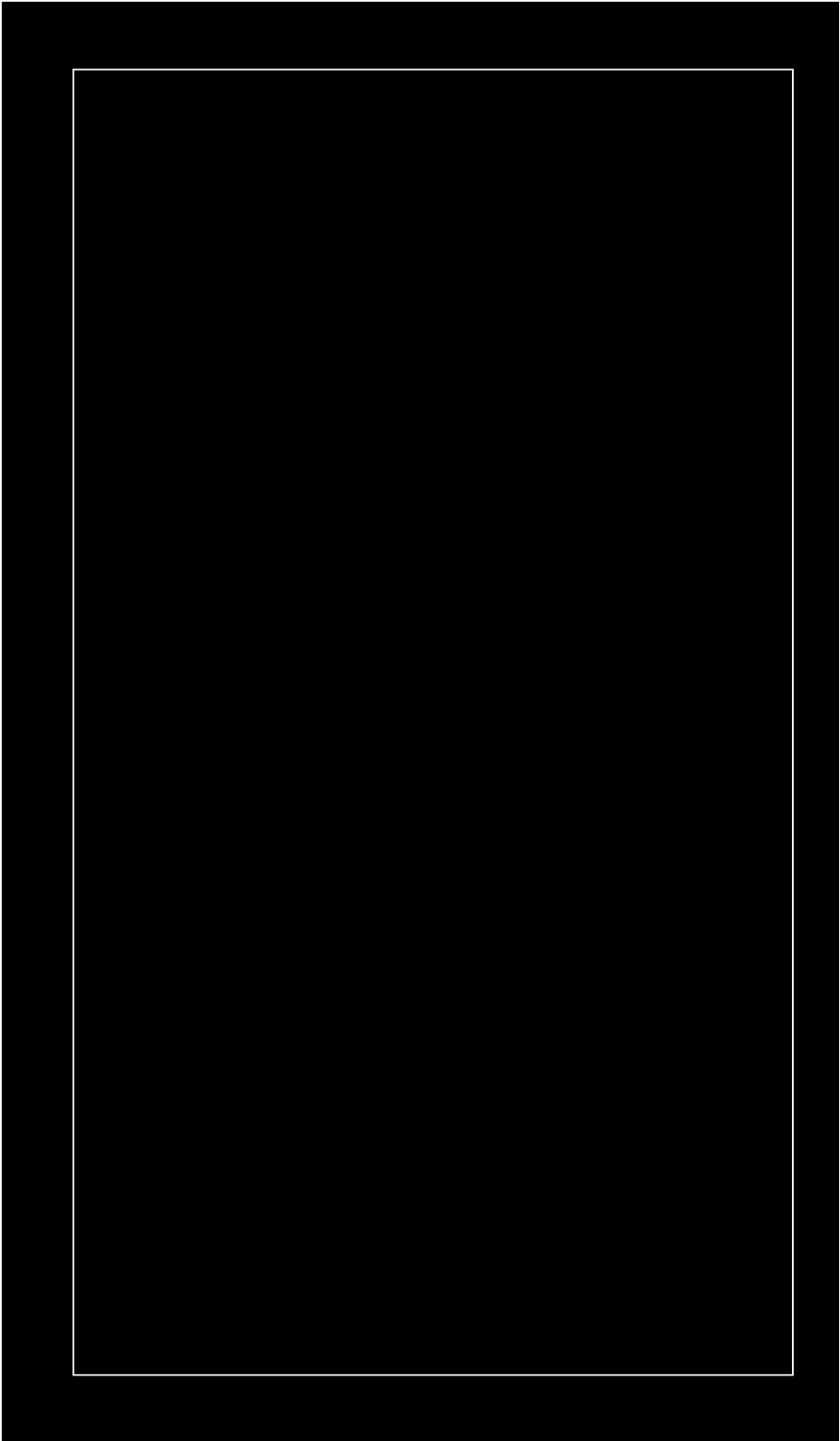

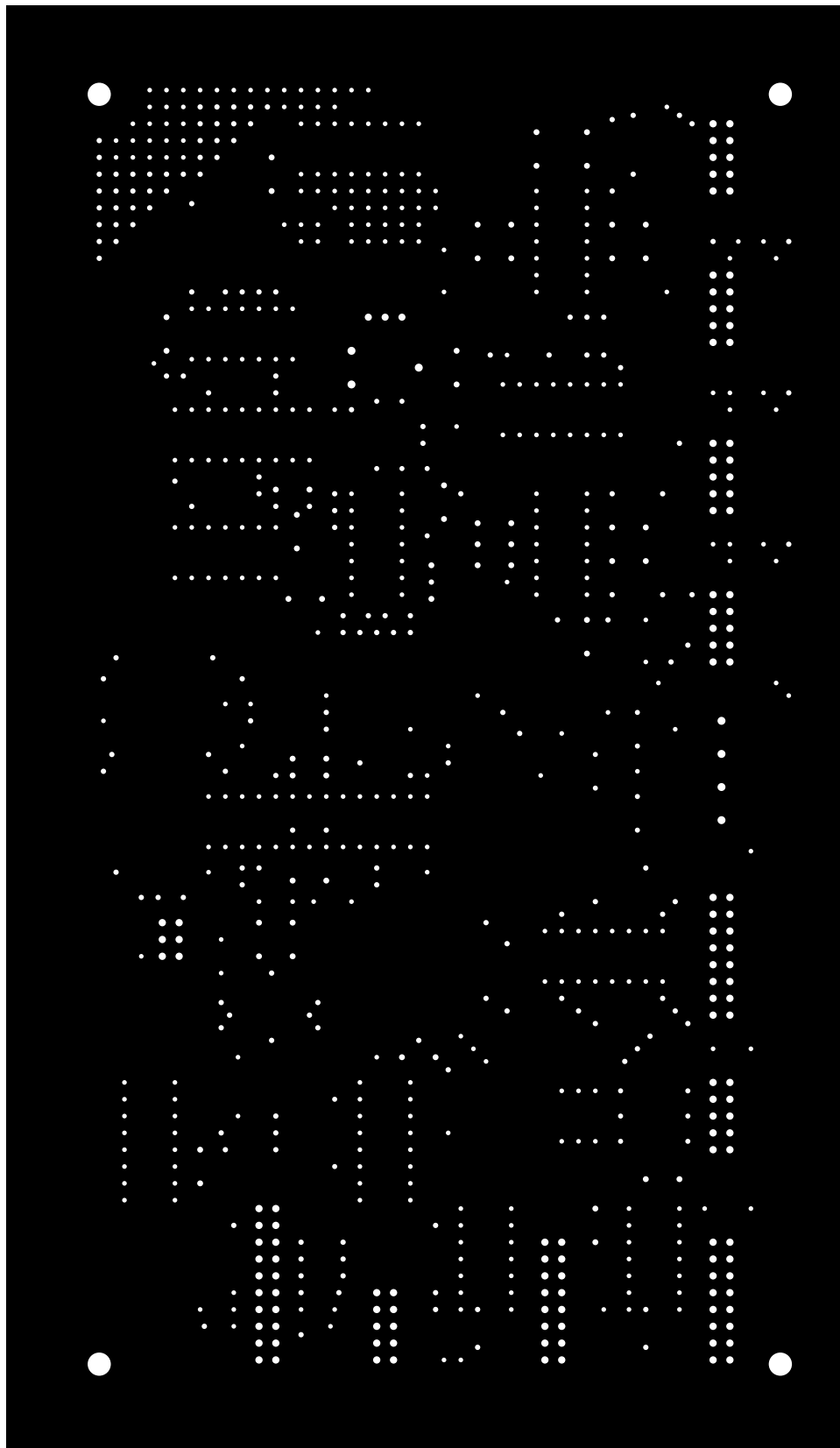

plated-drill (mirrored), scale = 1:1.000
pcb/main.pcb

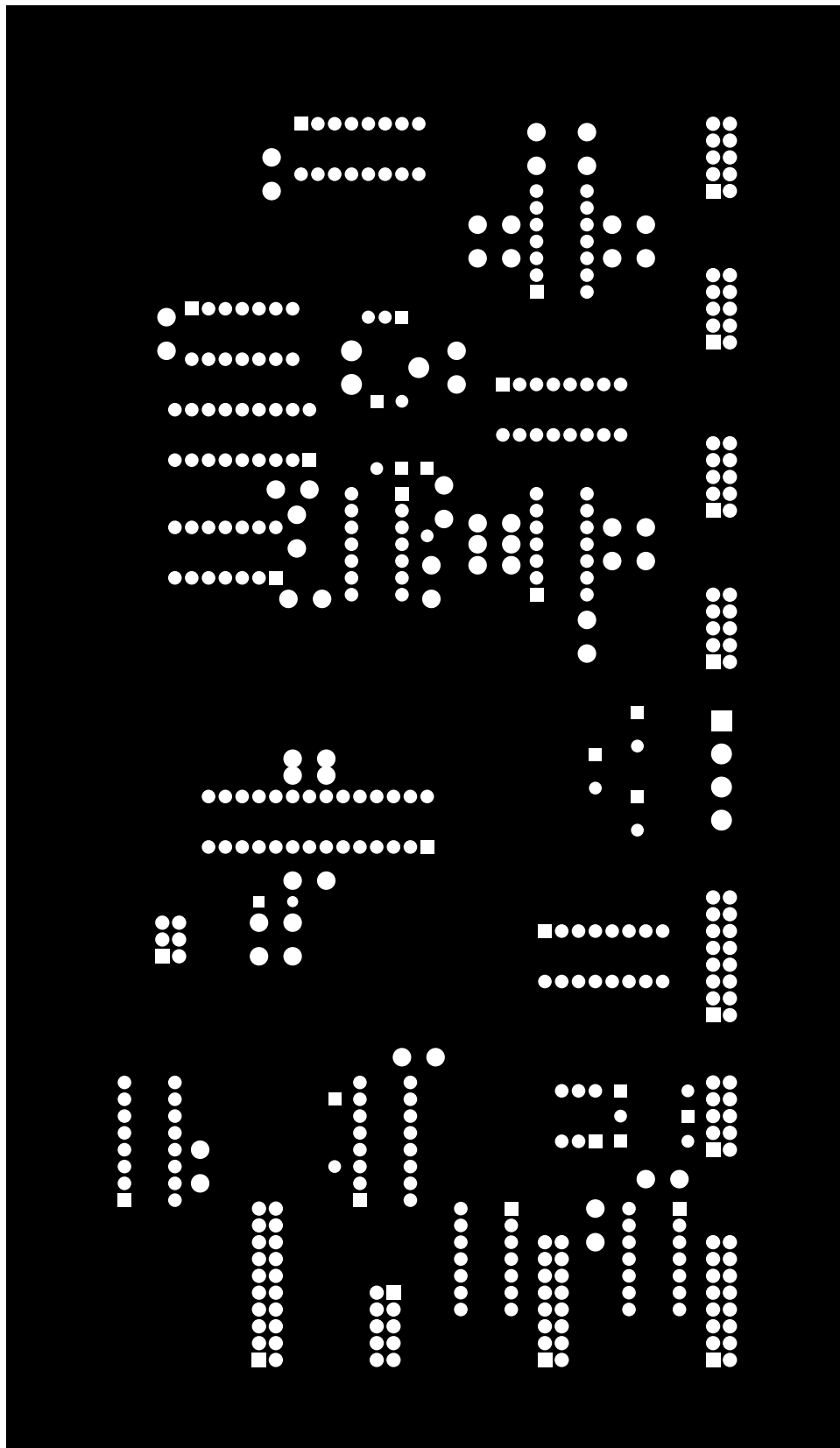

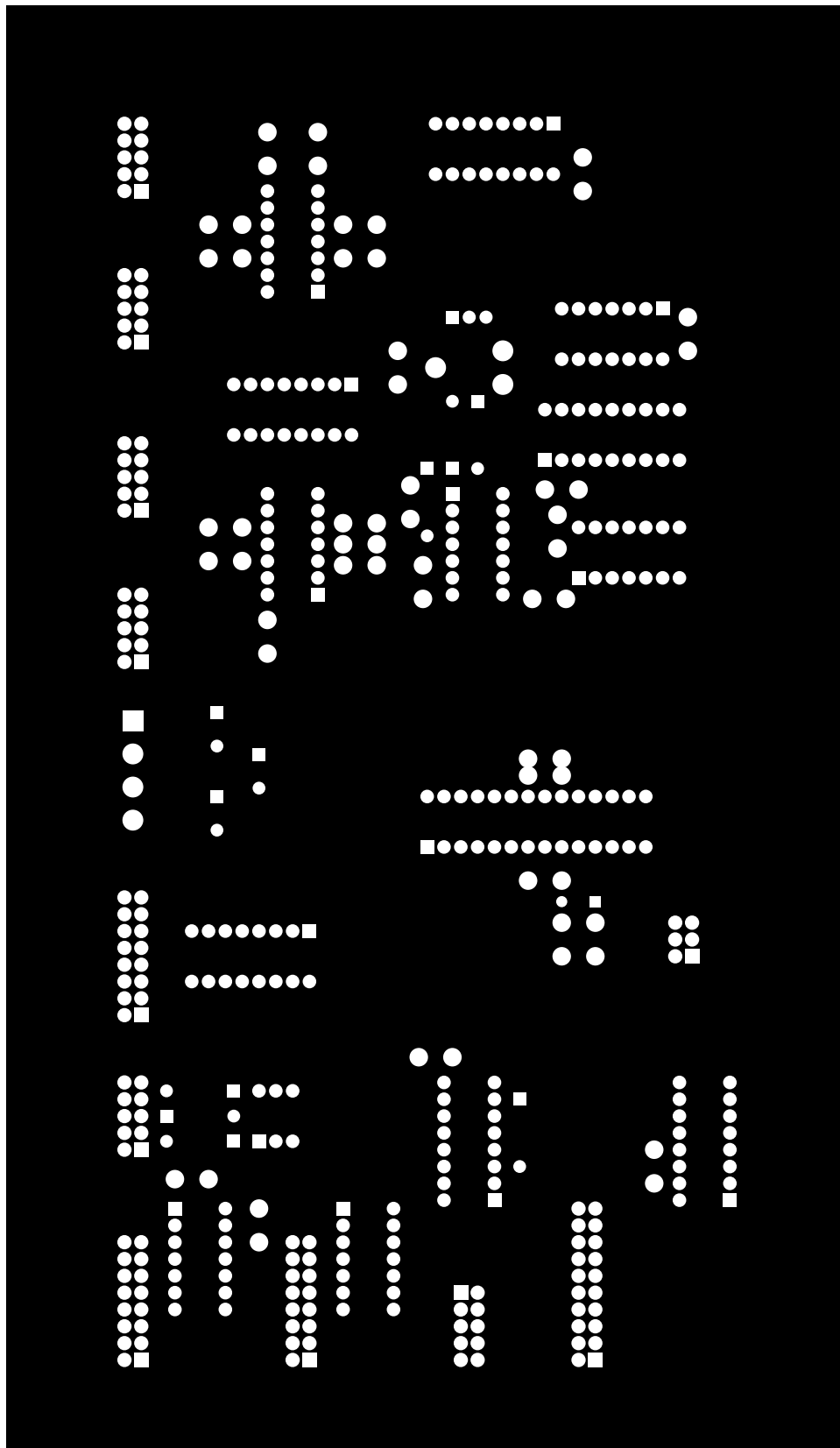

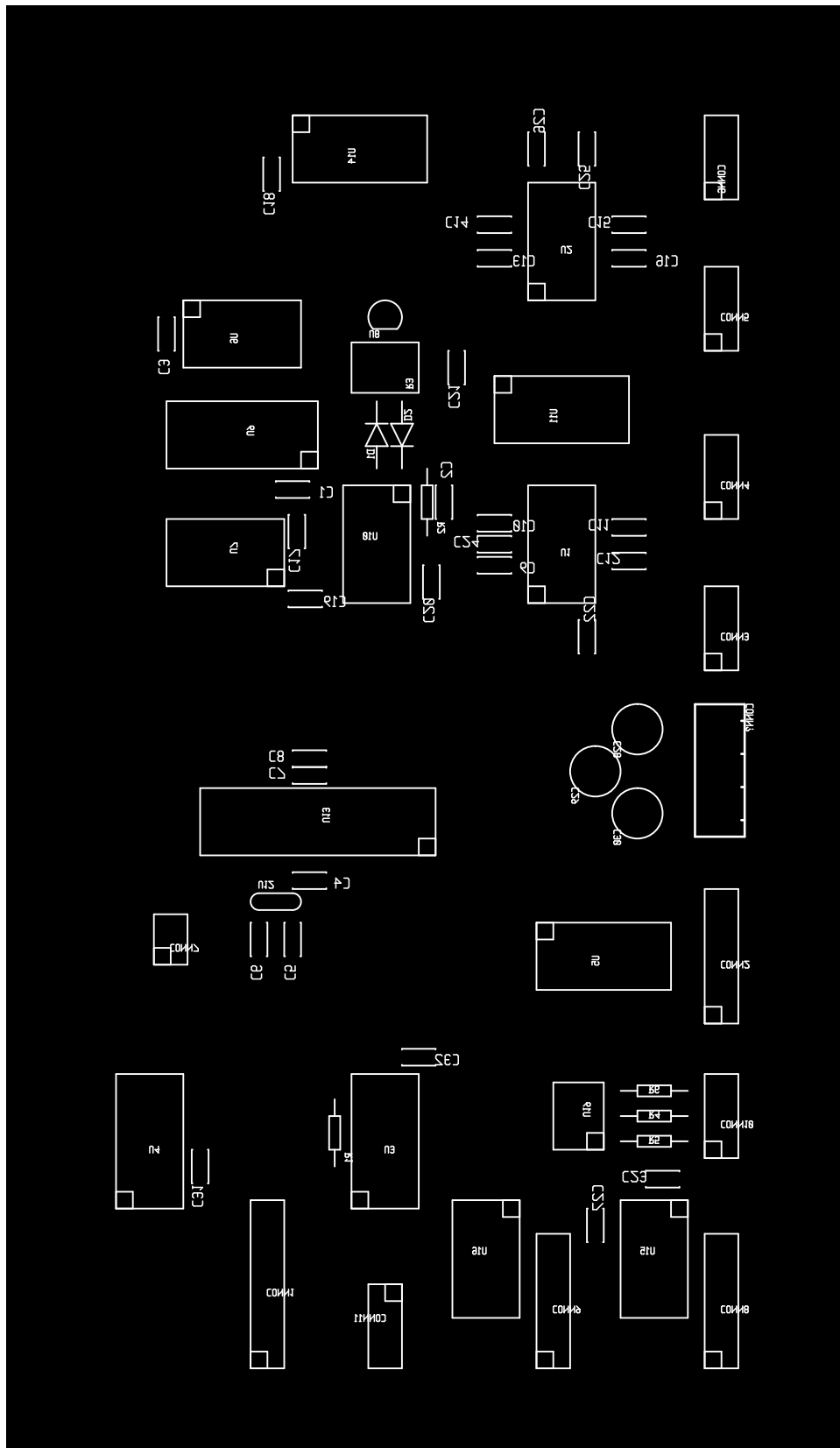

frontsilk (mirrored), scale = 1:1.000
pcb/main.pcb

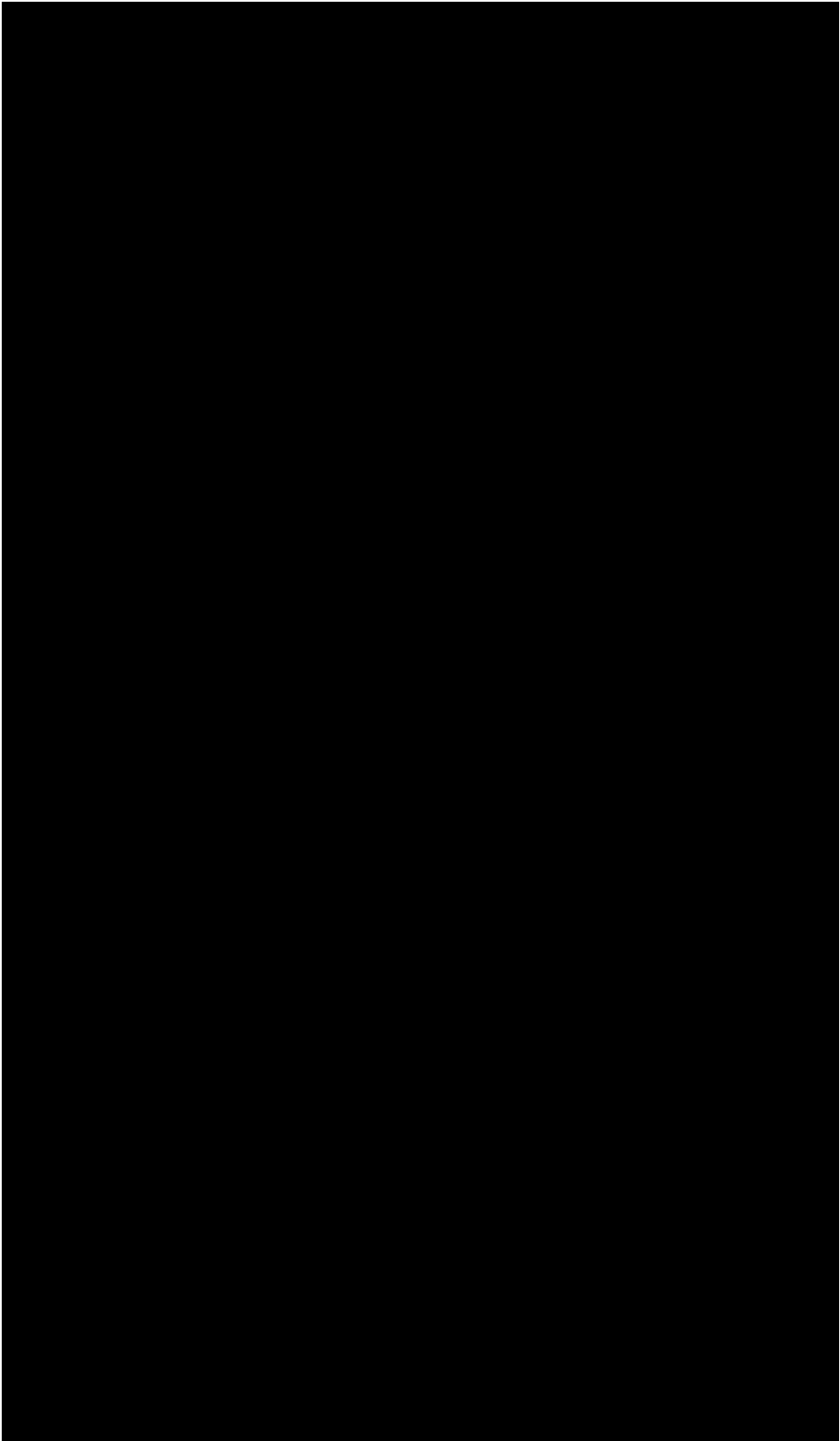

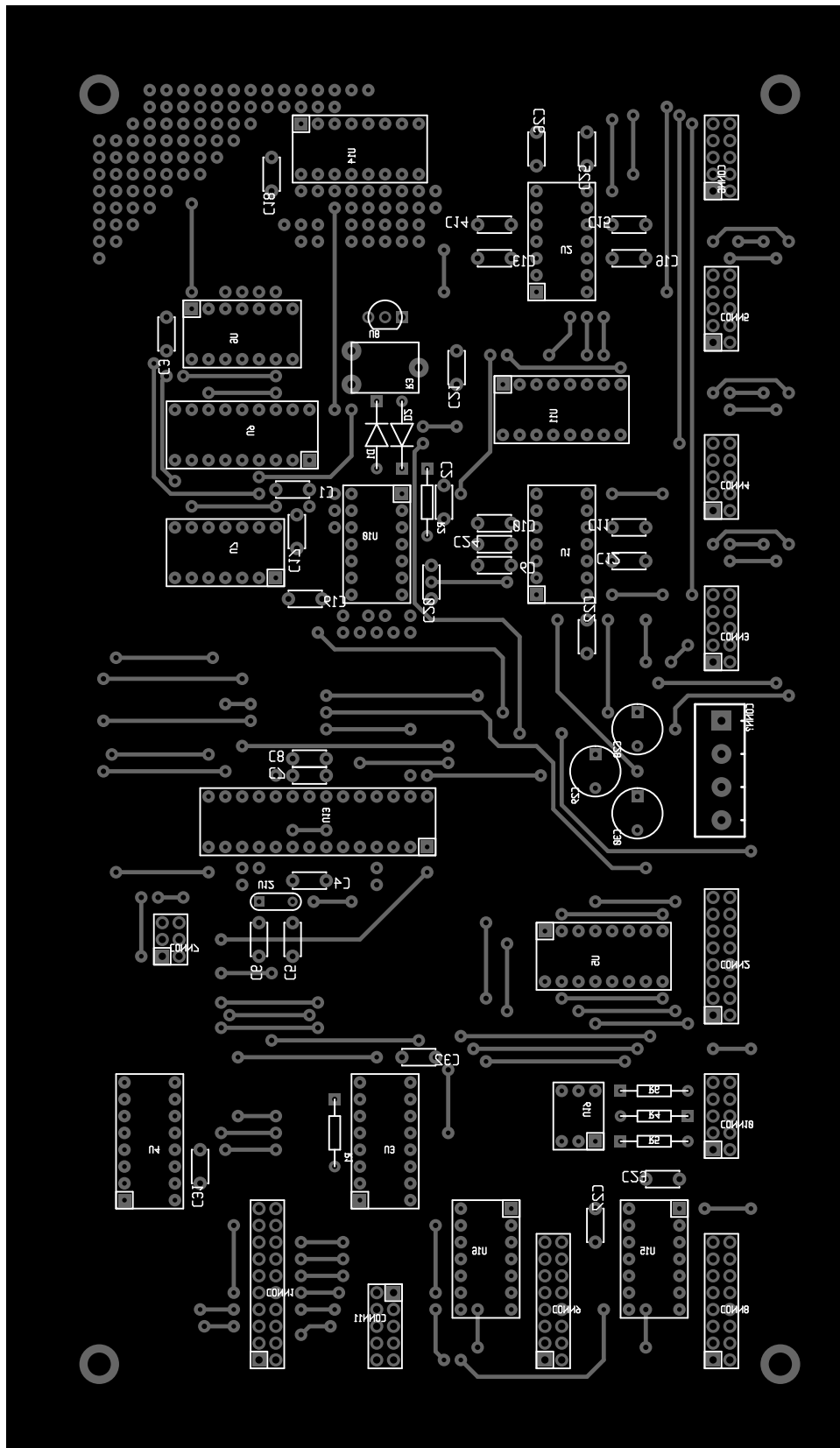

frontassembly (mirrored), scale = 1:1.000
pcb/main.pcb

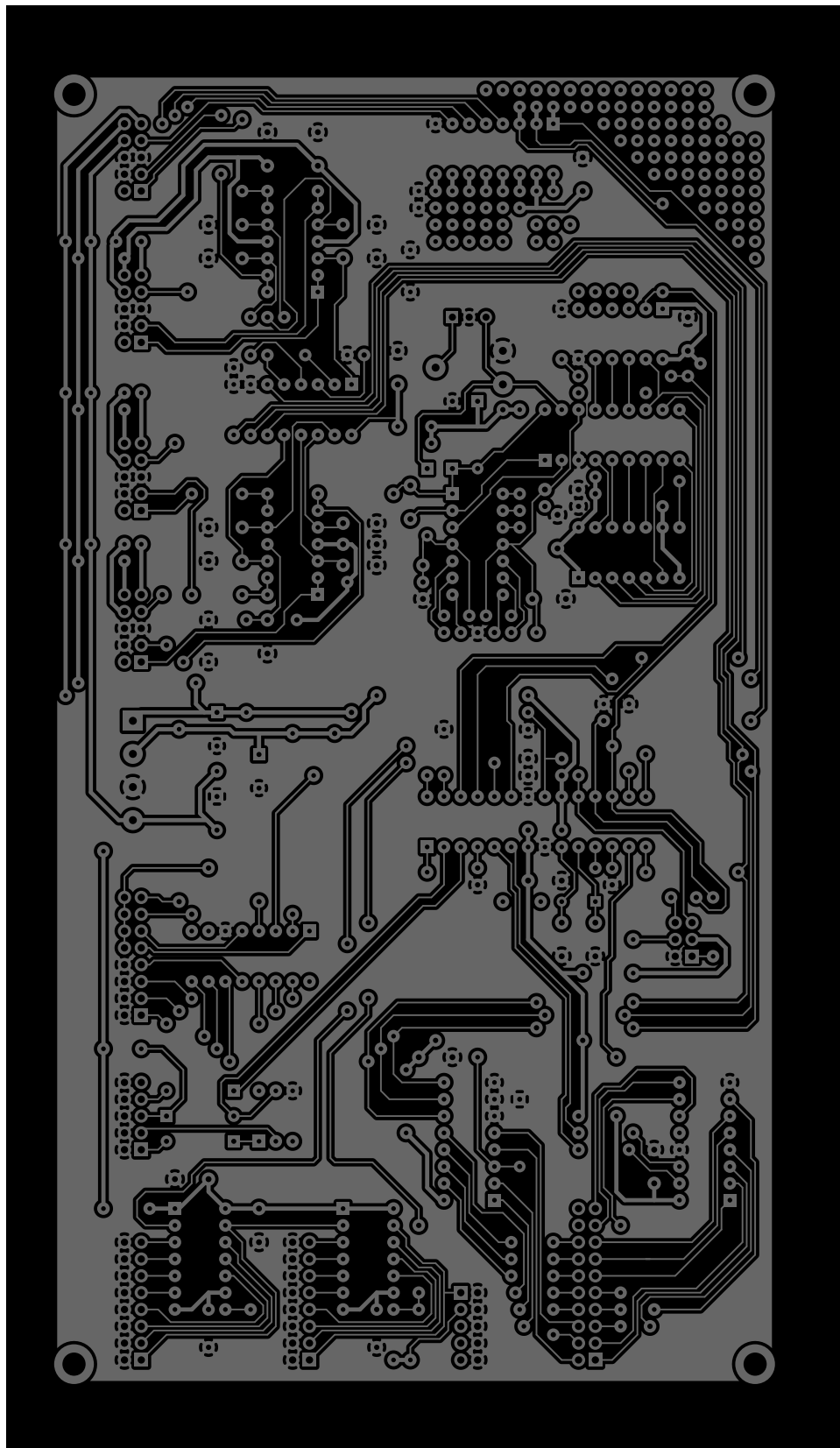

backassembly, scale = 1:1.000
pcb/main.pcb

